

Disc 285x285



220-240V, 50/60Hz

NO: Kan kun installeres og vedlikeholdes av en registrert installasjonsvirksomhet.
DK: Må kun installeres og vedlikeholdes af uddannet elektriker.
SE: Skall installeras och underhållas av behörig elektriker.
EN: Only to be installed and maintained by an authorized electrician.
FR: Doit être installé et maintenu par un électricien qualifié.
NL: Mag alleen geïnstalleerd en onderhouden worden door een bevoegde elektricien.
DE: Dieses Produkt darf nur durch autorisiertes Personal (z.B. Elektro-Installateur) angeschlossen, in Betrieb genommen und gewartet werden.
FI: Asentaa ja huoltaa saa vain valtuutettu sähköasentaja

NO: Skru av strømmen før montering.
DK: Sluk for strømmen inden montering.
SE: Stäng av strømmen innan montering.
EN: Turn off power before installing.
FR: Couper le courant avant l'installation.
NL: Stroom uitschakelen voor u het toestel installeert.
DE: Vor Installationsarbeiten den Strom abschalten.
FI: Sammuta virta ennen kytkemistä

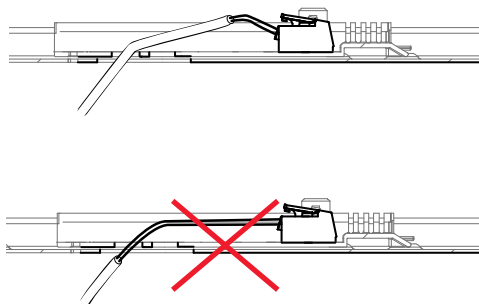
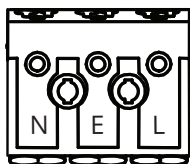
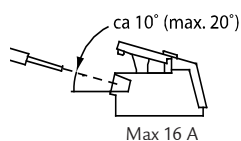
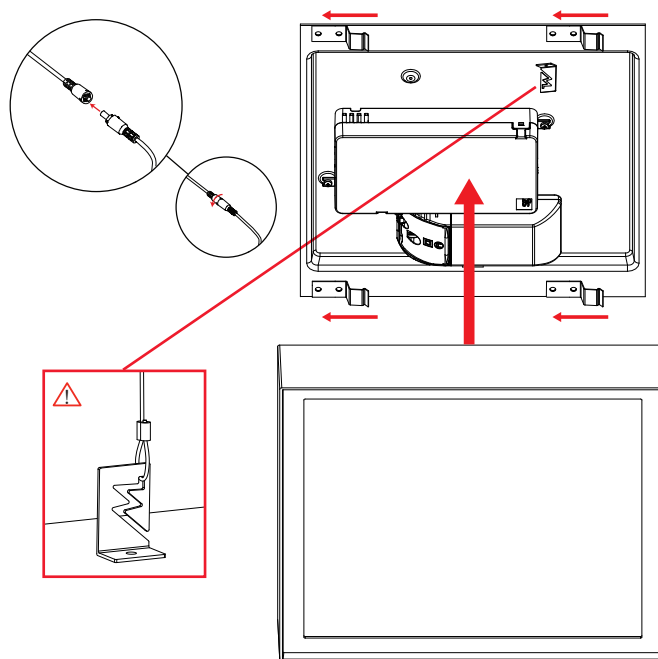
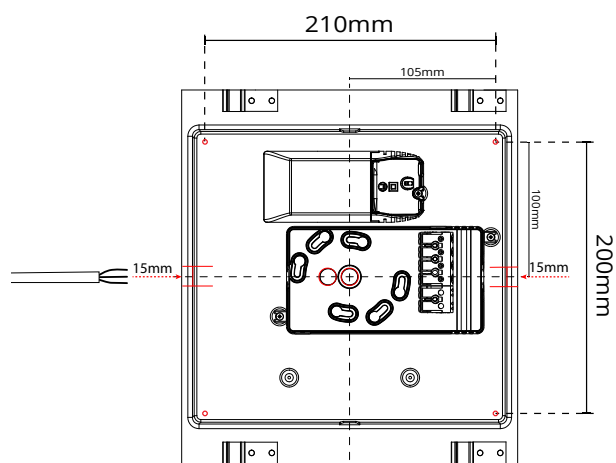

NORWAY
SG Armaturen AS
 Skytterheia 25
 N-4790 Lillesand

Tel: +47 37 50 03 00
 firmapost@sg-as.no
 www.sg-as.no

SWEDEN
SG Armaturen AB
 Tel: +46 31 81 71 10
 info@sg-ab.se
 www.sg-ab.se

FINLAND
SG Armaturen Oy
 Tel: +358 02 07 30 39 60
 info@sg-oy.fi
 www.sg-oy.fi

DENMARK
SG Armaturen A/S
 Tel: +45 70 70 72 13
 info@sg-as.dk
 www.sg-as.dk

UNITED KINGDOM
SG Lighting LTD
 Tel: +47 37 50 03 00
 info@sighting.co.uk
 www.sighting.co.uk

FRANCE
SG Lighting SA/NV
 Tel: +33(0) 4 94 93 00 00
 info.france@sighting.fr
 www.sighting.net

BENELUX
SG Lighting SA/NV
 Tel: +32(0) 15 20 72 71
 info.benelux@sighting.net
 www.sighting.net

GERMANY
SG Leuchten GmbH
 Tel: +49 40 23 99 44 59
 info@sg-leuchten.de
 www.sg-leuchten.de

INTERNATIONAL
SG Lighting Co Ltd.
 Tel: +86 769 88 49 20 88
 cindy@sighting.cn
 www.sg-as.com

Dipswitch

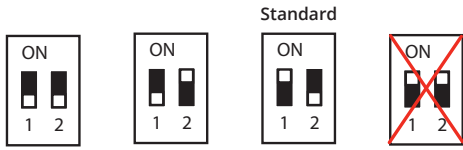

mA	500	600	700	800
Im	71%	86%	100%	-

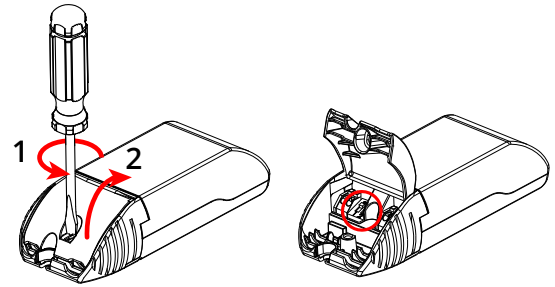

Sensor Dim



NO: Max antall armaturer er begrenset av sikringen
 DK: Det maksimale antal armaturer er begrænset af afbryderen
 SE: Max antal armaturer begränsas av säkringen.
 EN: Max number of fixtures is limited by the circuit breaker
 FR: Le nombre maximum de montages est limité par le disjoncteur
 NL: Max. aantal armaturen beperkt door de stroomonderbreker
 DE: Die maximale Anzahl der Geräte ist abhängig vom eingesetzten Leitungsschutzschalter
 FI: Valaisinten maksimimäärä määräytyy sulakkeen koon mukaan

Push

No Push

		1	2
⌚	Hold time	10 minutes	1 1
		5 minutes	0 1
		1 minute	1 0
		5 seconds	0 0
📶	Motion sensitivity	High	1 1
		Medium	0 1
		Low	1 0
		Off	0 0
☀️	Daylight sensitivity	Low	1 1
		Medium	0 1
		High	1 0
		Off	0 0
🌙	Midnight cut	On	1
		Off	0
%	Basic light	On	1
		Off	0

Hold time

	1	2
10 min	1	1
5 min	0	1
1 min	1	0
5 sec	0	0

Rev: 09.11.2022

<p>NORWAY SG Armaturen AS Skytterheia 25 N-4790 Lillesand Tel: +47 37 50 03 00 firmapost@sg-as.no www.sg-as.no</p>	<p>SWEDEN SG Armaturen AB Tel: +46 31 81 71 10 info@sg-ab.se www.sg-ab.se</p>	<p>DENMARK SG Armaturen A/S Tel: +45 70 70 72 13 info@sg-as.dk www.sg-as.dk</p>	<p>FRANCE SG Lighting SA/NV Tel: +33(0) 4 94 93 00 00 info.france@sglighting.fr www.sglighting.net</p>	<p>GERMANY SG Leuchten GmbH Tel: +49 40 23 99 44 59 info@sg-leuchten.de www.sg-leuchten.de</p>	<p>FINLAND SG Armaturen Oy Tel: +358 02 07 30 39 60 info@sg-oy.fi www.sg-oy.fi</p>	<p>UNITED KINGDOM SG Lighting LTD Tel: +47 37 50 03 00 info@sglighting.co.uk www.sglighting.co.uk</p>	<p>BENELUX SG Lighting SA/NV Tel: +32(0) 15 20 72 71 info.benelux@sglighting.net www.sglighting.net</p>	<p>INTERNATIONAL SG Lighting Co Ltd. Tel: +86 769 88 49 20 88 cindy@sgdgc.com www.sg-as.com</p>
---	--	--	---	---	---	--	--	--

Motion sensitivity

	3	4
High	1	1
Medium	0	1
Low	1	0
Off	0	0

1

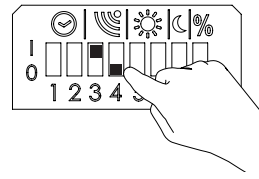

2

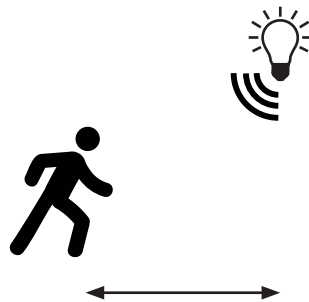
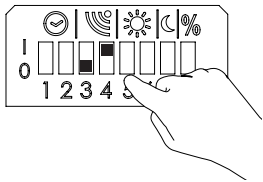

3

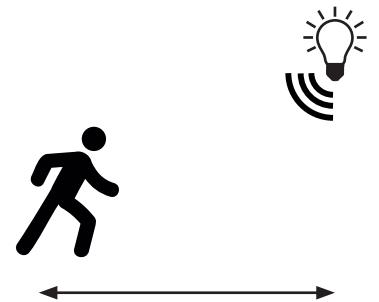
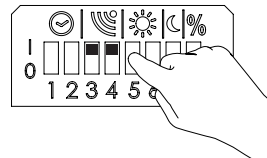

Light levels - Basic light and max light

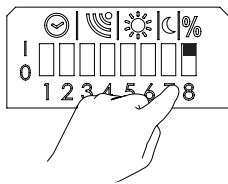

1

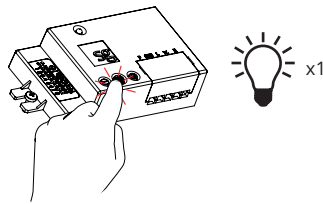

2

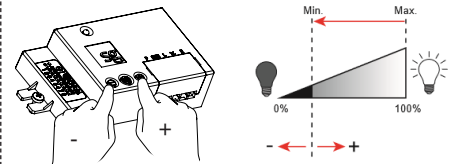

Basic light

3

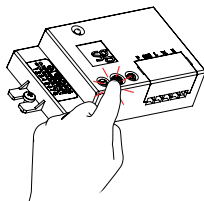

4

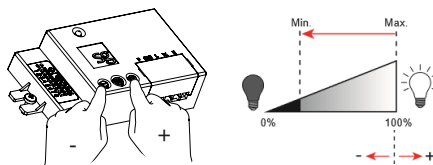

Maximum light level

5

